

# Hillsborough Drapery Hardware Order Sheet

Rods - specify rod size with a circle or check mark

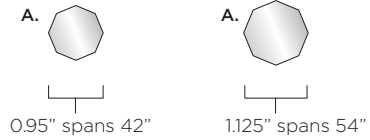

Rings - specify ring style with a circle or a check mark

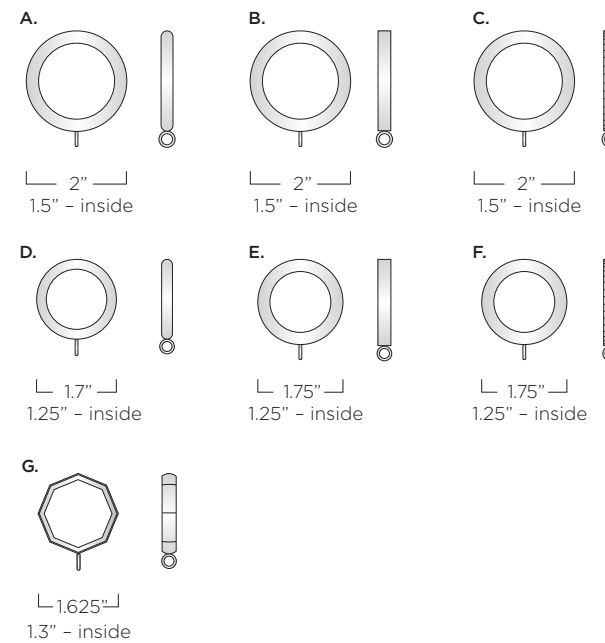

End Bracket Return / Top View

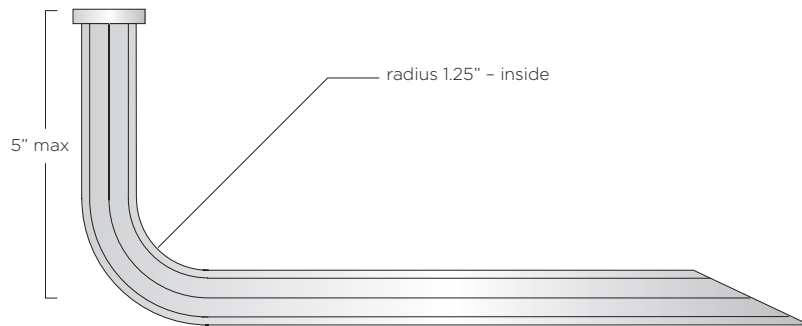

End Bracket Return / Side View

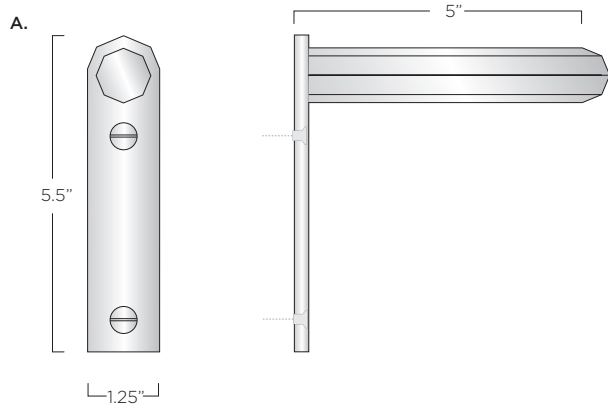

Center Bracket with saddle

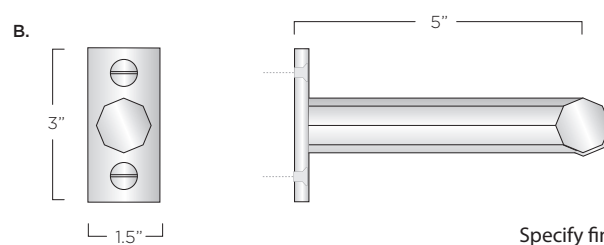

Specify finish Light medium or dark \_\_\_\_\_

Specify finish warm silver with plated rings (specialty finish contact T+R for pricing) \_\_\_\_\_

Specify projection from wall to C/L of rod maximum is 5" wall to C/L of rod \_\_\_\_\_

Center Bracket with integral splice

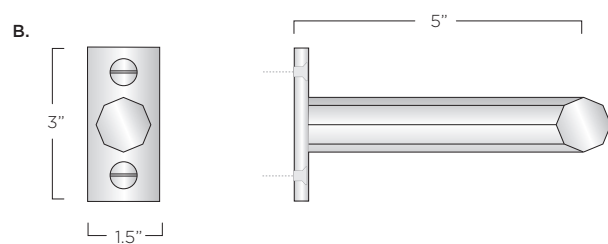

Center Bracket with pin

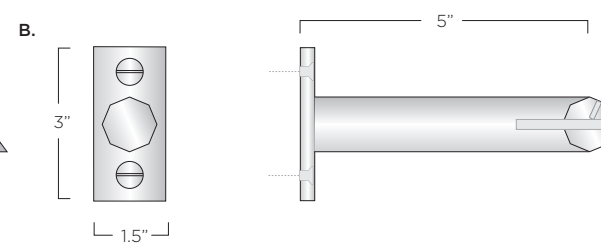

Center brackets always available with horizontal or vertical wall mounting plates and often customized to accommodate site conditions

## Hillsborough Drapery Hardware Order Sheet

rod set one

Length of rod \_\_\_\_\_

Number of end brackets (usually 2) \_\_\_\_\_

Number of center supports \_\_\_\_\_ Note that 2 or more center supports can trigger the need for pass through brackets and rings depending on your stack

Number of rings \_\_\_\_\_ pass through rings required? Y N If so tell us how many regular and how many pass through rings you will need.

Wands or batons needed and if so what length \_\_\_\_\_

Splices required or desired \_\_\_\_\_ Note we will review splices on the shop drawing

Special configuration? Bay or curved wall? Right angle elbow? Rod dies into a wall? Please provide a sketch to the right

---

rod set two

Length of rod \_\_\_\_\_

Number of end brackets (usually 2) \_\_\_\_\_

Number of center supports \_\_\_\_\_ Note that 2 or more center supports can trigger the need for pass through brackets and rings depending on your stack

Number of rings \_\_\_\_\_ pass through rings required? Y N If so tell us how many regular and how many pass through rings you will need.

Wands or batons needed and if so what length \_\_\_\_\_

Splices required or desired \_\_\_\_\_ Note we will review splices on the shop drawing

Special configuration? Bay or curved wall? Right angle elbow? Rod dies into a wall? Please provide a sketch to the right

---

rod set three

Length of rod \_\_\_\_\_

Number of end brackets (usually 2) \_\_\_\_\_

Number of center supports \_\_\_\_\_ Note that 2 or more center supports can trigger the need for pass through brackets and rings depending on your stack

Number of rings \_\_\_\_\_ pass through rings required? Y N If so tell us how many regular and how many pass through rings you will need.

Wands or batons needed and if so what length \_\_\_\_\_

Splices required or desired \_\_\_\_\_ Note we will review splices on the shop drawing

Special configuration? Bay or curved wall? Right angle elbow? Rod dies into a wall? Please provide a sketch to the right

---

notes:

1. Contact us if you need double rods in this style, we have done this customization.
2. This hardware is high quality solid sand cast bronze and will require solid blocking at all bracket locations.
3. Quotations for all custom hardware are NOT final until the shop drawings are complete and approved.